



深圳市美特光电子有限公司

SHENZHEN MATELIGHT ELECTRONICS CO., LTD

产品规格书 SPECIFICATION

| | | | |
|-----------------------|--|-----------------|--------------------|
| 顾客名称 Customer | | 产品名称 Product | 片式 LED Chip LED |
| 顾客部品号 Customer No. | | 产品型号 Type | MATE-C170KSKT |

| 顾客确认 APPROVED SIGNATURES | | | |
|-----------------------------|--|--|--|
| | | | |

地址：深圳市福田区深南中路佳和强大厦A座8楼A-830.A-831室
Add: Room A-830-A831, 8th Floor of Block A, Middle Shennan Road,
Jia He Hua Qiang Building, Futian District, Shenzhen ,China

电话 (Tel) : 0086-0755-83998134

传真 (Fax) : 0086-0755-83461747

邮编 (Zip) : 518031

<http://www.matelight.cn>

| 研究开发中心 Research & Development Center | | |
|---|-------------|------------|
| 批准 APPROVE | 审核 CHECK | 制定 DRAW |
| | | |
| 版本号 (Version NO) : B1 | | |
| 发放日期 (Release Date): 2012-03-20 | | |

MATE-C170KSKT

片式发光二极管
Chip Light Emitting Diode

技术数据表 Technical Data Sheet

本产品主要作为信号指示及照明的电子元件广泛应用于各类使用表面贴装结构的电子产品中，如家用电器的开关指示灯、手机键盘灯、汽车仪表盘照明等。
This product is generally used as indicator and illuminant for electronic equipment such as household appliance, communication equipment, and dashboard.



特性： 管芯材料： AlGaInP
Material:

发光颜色： 黄色
Emitting Color: Yellow

Features:

封装材料： 环氧树脂
Encapsulation: Resin

焊接方法： 无铅回流焊
Soldering methods: Pb-Free reflow soldering

光强度高，功耗低，可靠性好，寿命长
High Luminous Intensity ,Low Power Dissipation,good Reliability and Long Life

符合欧盟公布的 ROHS指令要求
Complied With ROHS Directive

目录

Catalogue

| | |
|--|---|
| 光电参数 | |
| Electro-Optical Characteristics..... | 2 |
| 典型特性曲线 | |
| Typical Characteristic Curves..... | 3 |
| 可靠性实验 | |
| Reliability Test Items And Conditions..... | 4 |
| 外形尺寸 | |
| Outline Dimensions..... | 5 |
| 包装 | |
| Packaging..... | 6 |
| 焊接指导 | |
| Guideline for Soldering..... | 8 |
| 使用注意事项 | |
| Precautions..... | 9 |

* 产品规格如因工艺改进而有所改变，恕不另行通知。

*The Specifications of the product may be modified for improvement without notice.

光电参数

Electro-Optical Characteristics

极限参数 (温度=25°C) :
Absolute Maximum Ratings (Temperature=25°C):

| 参数名称 Parameter | 符号 Symbol | 数值 Rating | 单位 Unit |
|----------------------------------|------------------|--------------|------------|
| 正向电流 Forward Current | I _F | 25 | mA |
| 正向脉冲电流* Peak Forward Current* | I _{FP} | 100 | mA |
| 反向电压 Reverse Voltage | V _R | 5 | V |
| 工作温度 Operating Temperature | T _{OPR} | -30 ~ +85 | °C |
| 贮存温度 Storage Temperature | T _{stg} | -40 ~ +100 | °C |
| 功耗 Power Dissipation | P _D | 65 | mW |

* 注: 脉冲宽度≤0.1ms, 占空比≤1/10
* Note: Pulse width≤0.1ms, Duty≤1/10

光电参数 (温度=25°C) :
Electro-Optical Characteristics (Temperature=25°C):

| 参数名称 Parameter | 符号 Symbol | 条件 Condition | 最小值 Min. | 典型值 Typ. | 最大值 Max. | 单位 Unit |
|--------------------------------------|-------------------|----------------------|-------------|-------------|-------------|------------|
| 反向电流 Reverse Current | I _R | V _R =5V | | | 10 | μA |
| 正向电压 Forward Voltage | V _F | I _F =20mA | 1.6 | 2.0 | 2.6 | V |
| 峰值波长 Peak Wavelength | λ _P | | | 592 | | nm |
| 主波长 Dominant Wavelength | λ _D | | 585 | 588 | 596 | nm |
| 半波宽度 Spectrum Radiation Bandwidth | Δλ | | | | 20 | nm |
| 光强 Luminous Intensity | I _v | | 100 | 125 | 190 | mcd |
| 视角 View Angle | 2θ _{1/2} | | | | 130 | deg. |

典型特性曲线

Typical Characteristics Curves

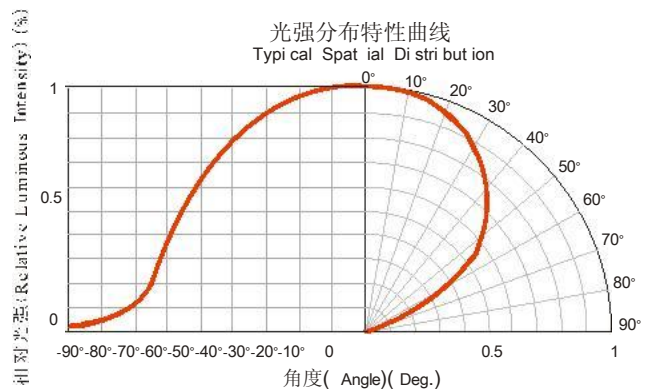
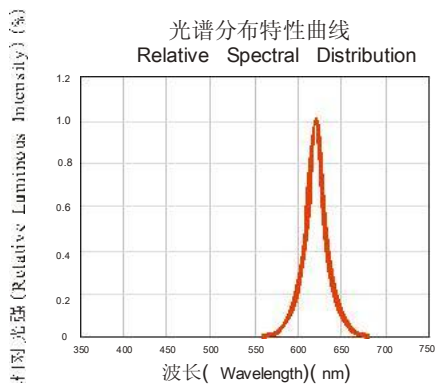
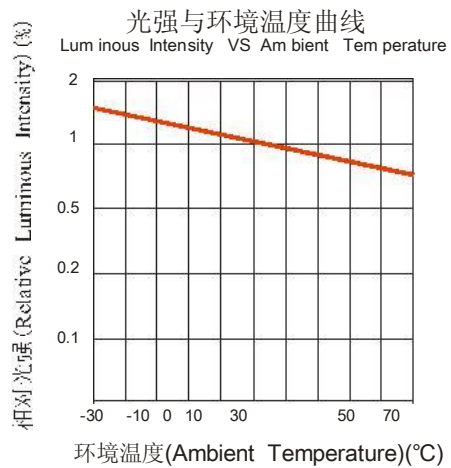
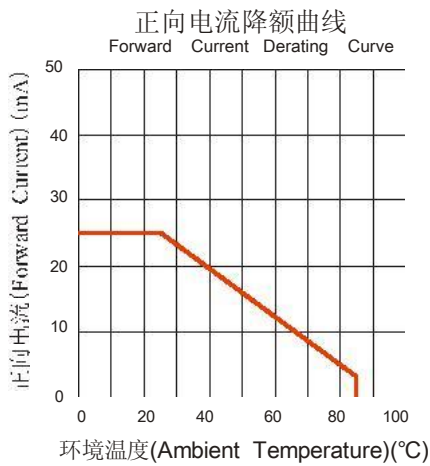
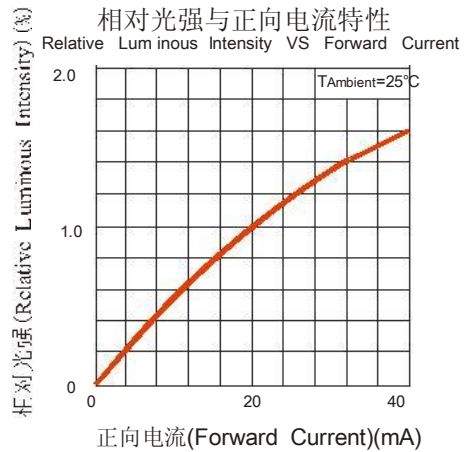
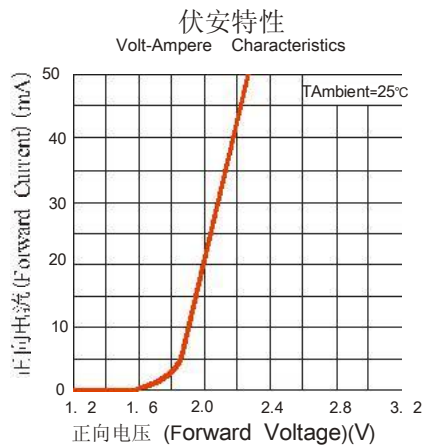

可靠性试验

Reliability Test Items And Conditions

| 实验项目 Test Items | 参考标准 Reference | 实验条件 Test Conditions | 时间 Time | 样品数 Quantity | 判据 Criterion |
|---|--------------------------|-----------------------------------|-----------------------|-----------------|-----------------|
| 冷热冲击 Thermal Shock | MIL-STD-202G | -40°C(15min)↔100°C(15min) | 循环 200次 200 cycles | 22 | 0/22 |
| 湿热循环 Temperature And Humidity Cyclic | JEITA ED-4701 200 203 | 25°C~65°C, 90%RH 24hrs./1cycle | 循环 10次 10 cycles | 22 | 0/22 |
| 高温储存 High Temperature Storage | JEITA ED-4701 200 201 | Ta=100°C | 1000h | 22 | 0/22 |
| 低温储存 Low Temperature Storage | JEITA ED-4701 200 202 | Ta=-40°C | 1000h | 22 | 0/22 |
| 常温寿命试验 Life Test | JESD22-A108D | Ta=25°C If =20mA | 1000h | 22 | 0/22 |
| 耐焊接热 Resistance to Soldering Heat | GB/T 4937, II,2.2&2.3 | Tsol*=(240±5)°C 10secs. | 2次 2 times | 22 | 0/22 |

失效判断标准 Criteria For Judging Damage

| 测试项目 Test Items | 符号 Symbol | 测试条件 Test Conditions | 判定标准 Criteria For Judging Damage |
|--------------------------------------|----------------|----------------------------------|---|
| 正向电压 Forward Voltage | V _F | I _F = I _{FT} | 初始值±10% Initial Data±10% |
| 反向电流 Reverse Current | I _R | V _R = 5V | I _R ≤10μA |
| 光强 Luminous Intensity | I _v | I _F = I _{FT} | 平均 I _v 衰减≤30%，单个 I _v 衰减≤50% Average I _v degradation≤30%; Single LED I _v degradation≤50% |
| 耐焊接热 Resistance to Soldering Heat | | | 无死灯。 No deaded light. |

*注: T_{sol}-锡液温度; I_{FT}: 典型电流 * Note: T_{sol}-Temperature of tin liquid; I_{FT}: Typical current.

外形尺寸

Outline Dimension

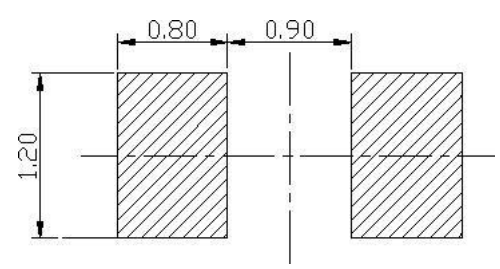
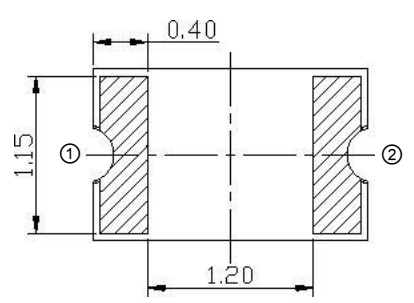
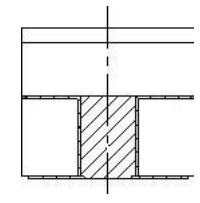
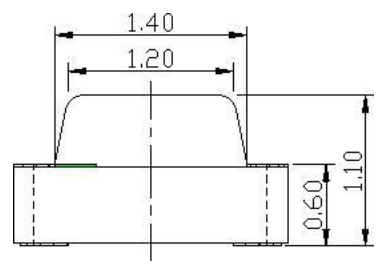
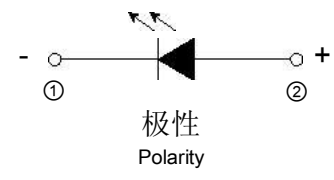
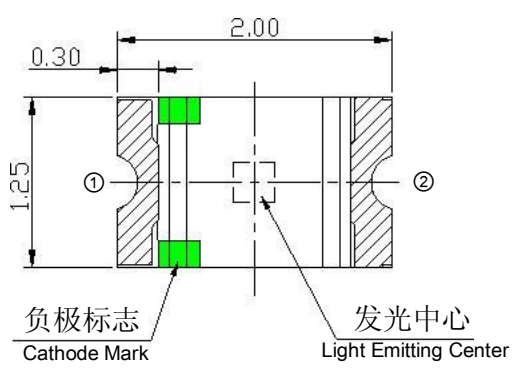

推荐焊盘尺寸
Recommended Soldering Pad

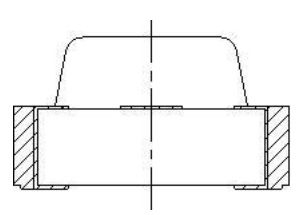

剖面图
Section View

敷铜区域:
Cuprum Area:

阻焊丝印区域:
Solder Resist:

公差: X.X±0.1, X.XX±0.05,单位为mm

* The Tolerances X.X±0.1, X.XX±0.05, Unit= mm*

包装 (1)

Packaging (1)

” 载带 Carrier Tape

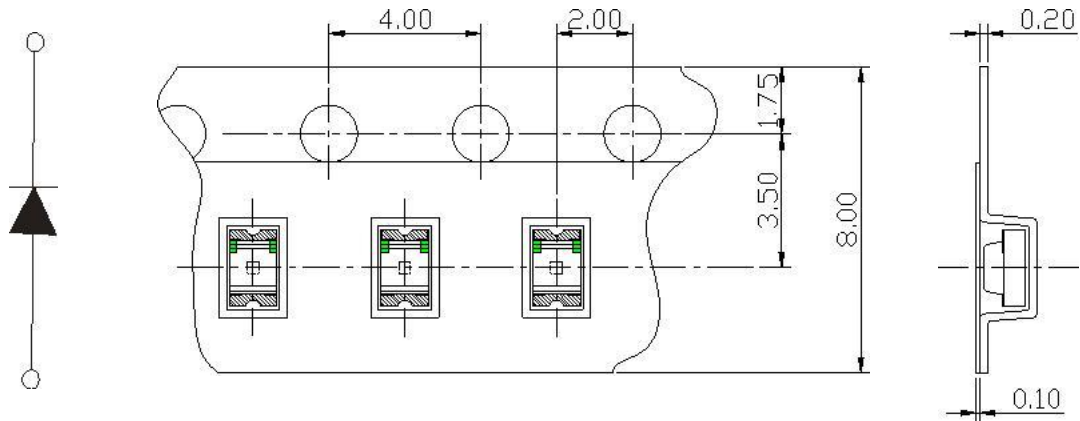

单位: mm, 未注公差: ± 0.1 mm
All dimensions in mm, tolerances unless mentioned is ± 0.1 mm.

” 编带细节 Details Of Carrier Tape

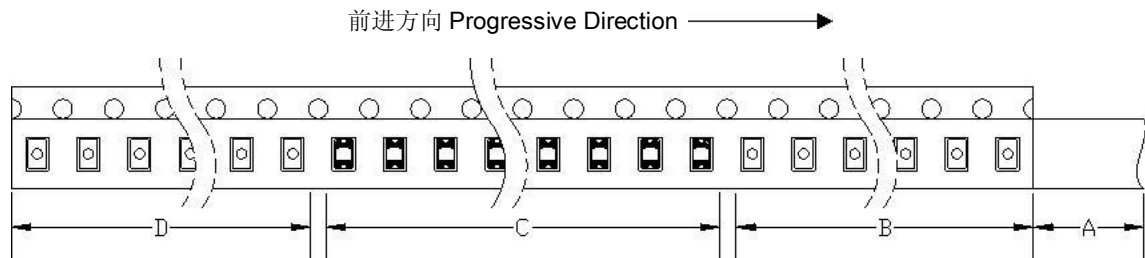

A: 盖带, 300 mm; B: 引导, 空带, 200mm; C: 编载产品 3000只; D: 尾部, 空带, 200mm
A: Top Cover Tape, 300mm; B: Leader, Empty, 200mm; C: 3000 Lamps Loaded; D: Trailer, Empty, 200mm.

” 带盘 Reel Dimension

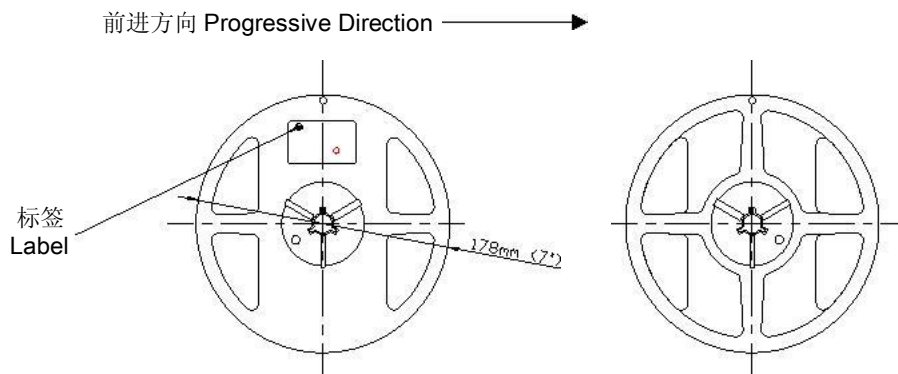

包装 (2)

Packaging (2)

" 防潮防静电包装 Moisture Proof and Anti-Electrostatic Foil Bag

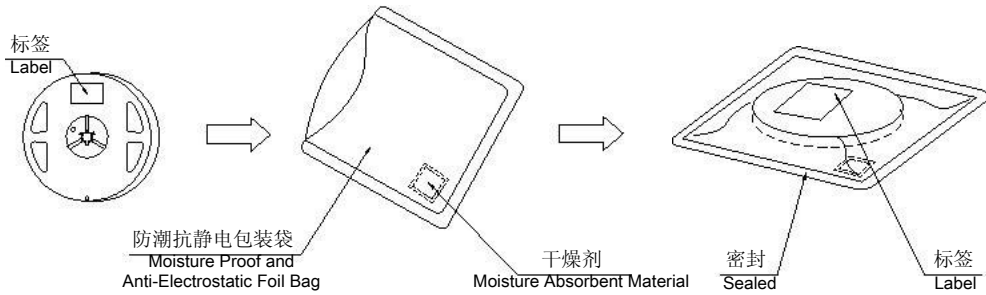

" 外包装箱 Cardboard Box

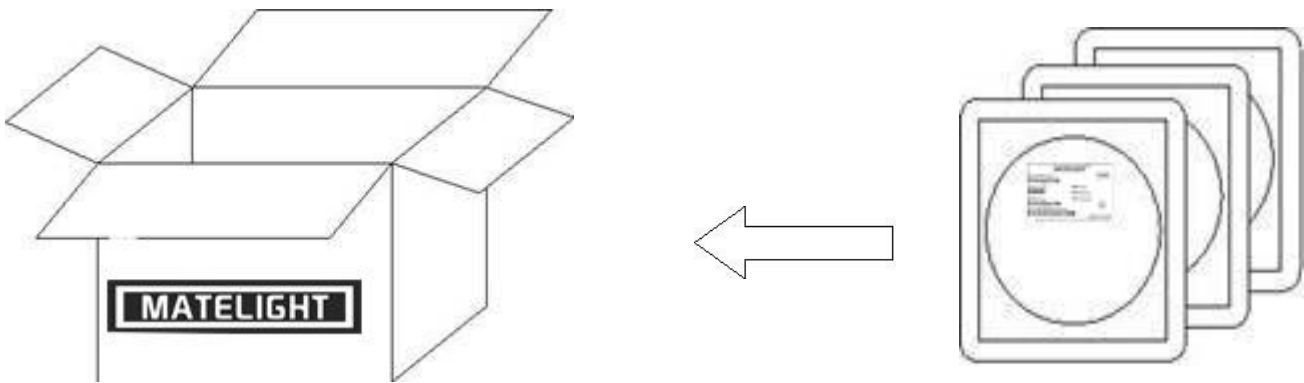

" 标签说明 Label Explanation

- TYPE: 产品型号
- QTY: 数量 Quantity
- BIN: 分档 Rank
- LOT: 批号 Lot Number
- λ d: 波长范围 Wavelength Range
- IV: 光强范围 Luminous Intensity Range
- VF: 正向电压范围 Forward Voltage Range
- IF: 测试电流 Testing Current

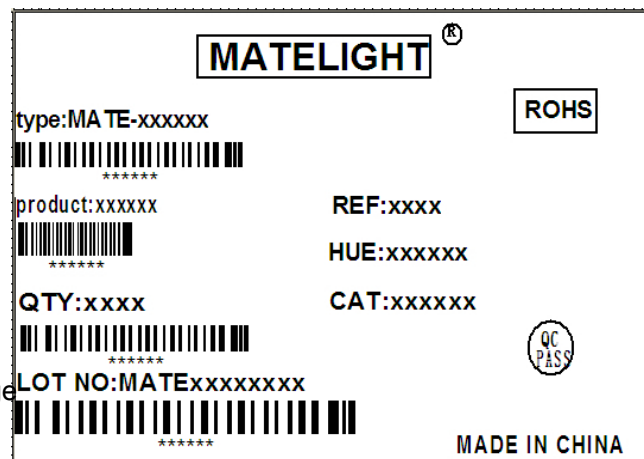

焊接指导 (1)

Guideline for Soldering (1)

1. 使用烙铁人手焊接

Hand Soldering

推荐使用功率低于 20W 的烙铁，焊接时烙铁的温度必须保持在 360°C 以下，且每个电极只能进行一次焊接，每次焊接的持续时间不得超过 3 秒。

人手焊接过程中的不慎操作易引起 LED 产品的损坏，应当小心谨慎。

A soldering iron of less than 20W is recommended to be used in Hand Soldering. Please keep the temperature of the soldering iron under 360°C while soldering. Each terminal of the LED is to go for less than 3 second and for one time only.

Be careful because the damage of the product is often started at the time of the hand soldering.

2. 回流焊接：推荐使用以下无铅回流焊接温度图进行。

Reflow Soldering: Use the conditions shown in the under Figure of Pb-Free Reflow Soldering.

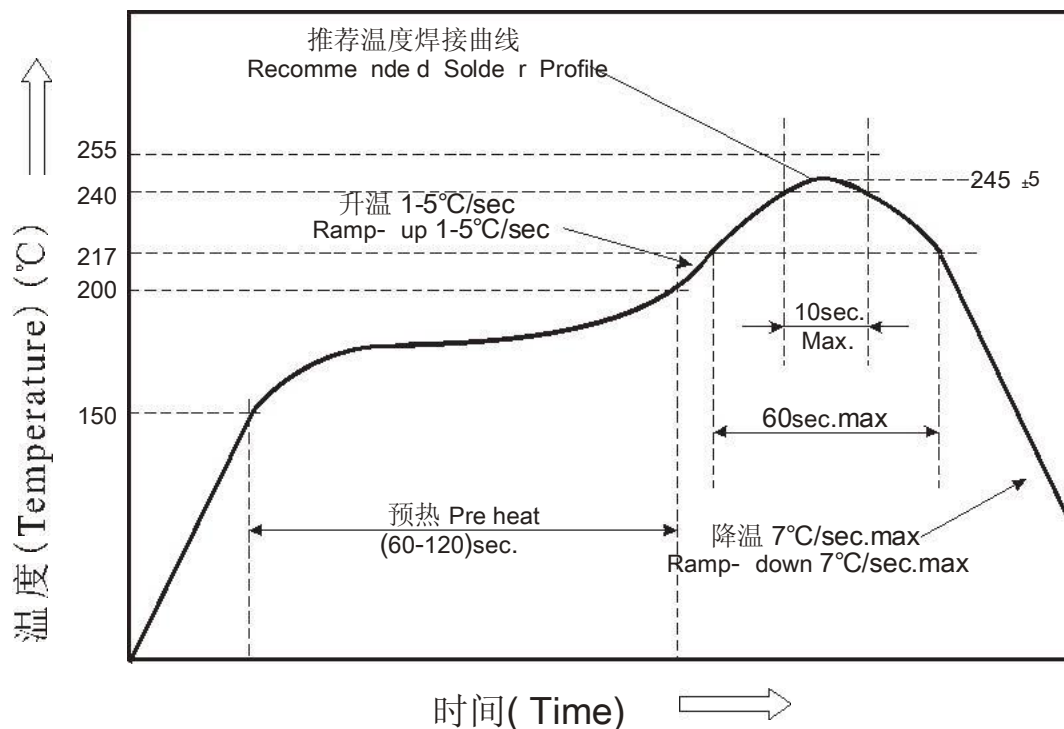

- 回流焊接最多只能进行两次。

Reflow soldering should not be done more than two times.

- 在回流焊接升温过程中，请不要对 LED 施加任何压力。

Stress on the LEDs should be avoided during heating in soldering process.

- 在焊接完成后，待产品温度下降到室温之后，再进行其他处理。

After soldering, do not deal with the product before its temperature drop down to room temperature.

焊接指导 (2)

Guideline for Soldering (2)

3. 清洗:

Cleaning

在焊接后推荐使用酒精进行清洗，在温度不高于 30°C 的条件下持续 3 分钟，不高于 50°C 的条件下持续 30 秒。使用其他类似溶剂清洗前，请先确认使用的溶剂不会对 LED 的封装和环氧树脂部分造成损伤。

超声波清洗也是有效的方法，一般最大功率不应超过 300W，否则可能对 LED 造成损伤。请根据具体的情况预先测试清洗条件是否会对 LED 造成损伤。

It is recommended that alcohol be used as a solvent for cleaning after soldering. Cleaning is to go under 30°C for 3 minutes or 50°C for 30 seconds. When using other solvents, it should be confirmed beforehand whether the solvent will dissolve the package and the resin or not.

Ultrasonic cleaning is also an effective way for cleaning. But the influence of Ultrasonic cleaning on LED depends on factors such as ultrasonic power. Generally, the ultrasonic power should not be higher than 300W. Before cleaning, a pre-test should be done to confirm whether any damage to LEDs will occur.

* 注意：此一般指导原则并不适用于所有 PCB 设计和焊接设备的配置。具体工艺受到诸多因素的影响，请根据特定的 PCB 设计和焊接设备来确定焊接方案。

* Note: This general guideline may not apply to all PCB designs and configurations of all soldering equipment. The technique in practice is influenced by many factors it should be specialized base on the PCB designs and configurations of the soldering equipment.

使用注意事项 (1)

Precautions (1)

1. 贮存:

Storage

- 本产品使用密封防潮抗静电袋包装，并附有干燥剂，未开封的产品有一年的保存时间。

Moisture proof and anti-electrostatic package with moisture absorbent material is used, to keep moisture to minimum.

- 开封前，产品须存放在温度不高于 30°C，湿度不高于 60%RH 的环境中。

Before opening the package, the product should be kept at 30°C or less and humidity less than 60% RH, and used within a year.

- 开封后，产品应在 24 小时内使用完。如未能使用完，余料须存放在湿度不高于 30°C，湿度不高于 10%RH 的环境中。建议工作环境为温度不高于 30°C，湿度不高于 60%RH。

After opening the package, the product should be soldered within 24 hours. If not, please store at 30°C or less and humidity less than 10%RH. It is recommended that the product be operated at the workshop condition of 30°C or less and humidity less than 60%RH.

- 对于尚未焊接的 LED，如果吸湿剂或包装失效，或者产品没有符合以上有效存储条件，烘焙可以起到一定的性能恢复效果。烘焙条件：(60±5) °C，持续 24 小时。

If the moisture absorbent material has fade away or the LEDs have exceeded the storage time, baking treatment should be performed based on the following condition: (60±5)°C for 24 hours.

使用注意事项 (2)

Precautions (2)

2. 设计建议:

Design Consideration

设计电路时，通过 LED 的电流不能超过规定的最大值，同时，还需使用保护电阻，否则，微小的电压变化将会引起较大的电流变化，可能导致产品损毁。

建议使用以下 (A) 电路，该电路能够很好的调节通过每个 LED 的电流；不推荐使用 (B) 电路，该电路在持续的电压驱动下，LED 的正向电压 (V_F) 发生变化，电流会随之而发生变化，可能使某些 LED 承受高于规定的电流值。

In designing a circuit, the current through each LED must not exceed the absolute maximum rating specified for each LED. In the meanwhile, resistors for protection should be applied, otherwise slight voltage shift will cause big current change, burn out may happen.

It is recommended to use Circuit A which regulates the current flowing through each LED rather than Circuit B. When driving LEDs with a constant voltage in Circuit B, the current through the LEDs may vary due to the variation in Forward Voltage (V_F) of the LEDs. In the worst case, some LED may be subjected to stresses in excess of Absolute Maximum Rating.

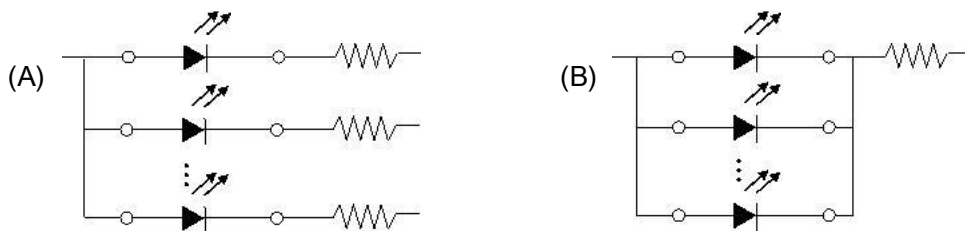

LED 的特性容易因为自身的发热和环境的温度的改变而发生改变。温度的升高会降低 LED 的发光效率、影响发光颜色等，所以在设计时应充分考虑散热的问题。

Thermal Design is paramount importance because heat generation may result in the Characteristics decline, such as brightness decreased, Color changed and so on. Please consider the heat generation of the LEDs when making system design.

使用注意事项 (3)

Precautions (3)

3. 其他事项:

Others

直接用手拿取产品不但会污染封装树脂表面, 也可能由于静电等因素导致产品性能的改变。过度的压力也可能直接影响封装内部的管芯和金线, 因此请勿对产品施加过度压力, 特别当产品处于高温状态下, 例如在回流焊接过程中。

When handling the product, touching the encapsulant with bare hands will not only contaminate its surface, but also affect on its optical characteristic. Excessive force to the encapsulant might result in catastrophic failure of the LEDs due to die breakage or wire deformation. For this reason, please do not put excessive stress on LEDs, especially when the LEDs are heated such as during Reflow Soldering.

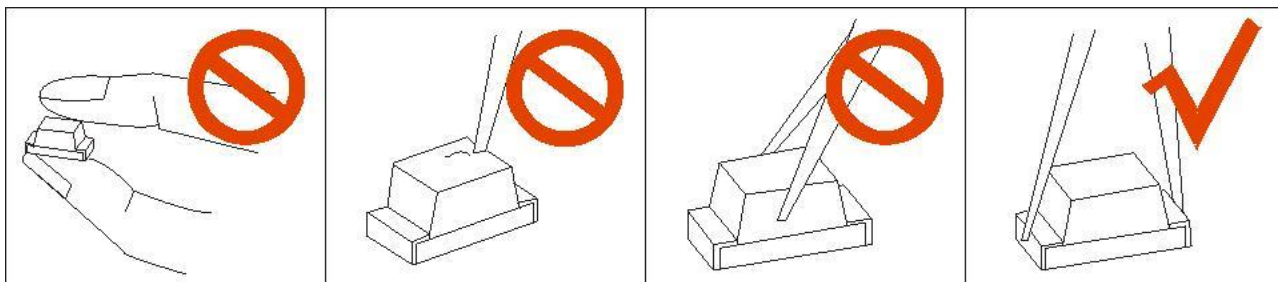

LED 的环氧树脂封装部分相当脆弱, 请勿用坚硬、尖锐的物体刮、擦封装树脂部分。在用镊子夹取的时候也应当小心注意。

The epoxy resin of encapsulant is fragile, so please avoid scratch or friction over the epoxy resin surface. While handling the product with tweezers, do not hold by the epoxy resin, be careful.

4. 反压保护

Reverse voltage protection

通常 LED 的反向漏电流都很小, 不会影响正常使用。如果 LED 长期遭受超过其所能承受的反向电压冲击时, LED 会被损伤, 反向漏电流会迅速变大, 引起 LED 迅速衰减。在设计中, 要注意控制反向电压, 建议加在 LED 上的反向电压值不超过 10V。

In generally the reverse current of LED is very small, it can't effect using the component normally, but when it often suffered the reverse voltage which exceed the limits of the component than it will be damaged, the reverse current increases rapidly causing the LED degenerating rapidly so when designing, please pay attention to control the reverse voltage we suggest the reverse voltage less than 10V.